

Air Conditioning  
Technical Data

FCAG-A



- > FCAG35AVEB
- > FCAG50AVEB
- > FCAG60AVEB
- > FCAG71AVEB
- > FCAG100AVEB
- > FCAG125AVEB

- > FCAG140AVEB



# TABLE OF CONTENTS

## FCAG-A

1	Features .....	2
2	Specifications .....	3
	Technical Specifications .....	3
	Electrical Specifications .....	4
3	Options .....	5
4	Dimensional drawings .....	6
	Dimensional Drawings with Accessories .....	6
	Dimensional Drawings with Fresh Air Intake .....	9
5	Centre of gravity .....	10
6	Piping diagrams .....	11
7	Wiring diagrams .....	12
	Wiring Diagrams - Single Phase .....	12
8	Sound data .....	13
	Sound Pressure Spectrum .....	13
9	Air flow patterns .....	17
	Air Flow Pattern - Cooling .....	17
	Air Flow Pattern - Heating .....	24

# 1 Features

360° air discharge for optimum efficiency and comfort

- Unified indoor unit can be combined with R-32 and R-410A outdoor units, simplifying stock
- Combining with R-32 Bluevolution technology, reduces environmental impact with 68% compared to R-410A, leads directly to lower energy consumption thanks to its high energy efficiency and has up to lower 16% refrigerant charge
- Daily automatic filter cleaning results in higher efficiency & comfort and lower maintenance costs. 2 filters available: standard filter and finer mesh filter (for fine dust applications e.g. clothing shops)
- Two optional intelligent sensors improve energy efficiency and comfort.
- Individual flap control: flexibility to suit every room layout without changing the location of the unit!
- Lowest installation height in the market: 214mm for class 20-63
- Modern style decoration panel is available in 3 different variations: white (RAL9010) with grey louvers, full white (RAL9010) or auto cleaning panel
- 5 different fan speeds available for maximum comfort
- Reduced energy consumption thanks to specially developed small tube heat exchanger, DC fan motor and drain pump
- Optional fresh air intake
- Branch duct discharge allows to optimize air distribution in irregular shaped rooms or to supply air to small adjacent rooms
- Standard drain pump with 675mm lift increases flexibility and installation speed



Infrastructure cooling	Presence & floor sensor	Home leave operation	Fan only	Auto-cleaning filter	Draught prevention	Auto cooling-heating changeover	Whisper quiet	Ceiling soiling prevention
Individual flap control	Vertical auto swing	Fan speed steps	Dry programme	Air filter	Weekly timer	Infrared remote control	Wired remote control	Centralised control
Auto-restart	Self diagnosis	Drain pump kit	Twin/triple/double twin application	Multi model application				

## 2 Specifications

2-1 Technical Specifications				FCAG35A	FCAG50A	FCAG60A	FCAG71A	FCAG100A	FCAG125A	FCAG140A	
Power input - 50Hz	Cooling	Nom.	kW	-					0.17		
	Heating	Nom.	kW	-					0.17		
Casing	Material			Galvanised steel plate							
Dimensions	Unit	Height/Width/Depth	mm	204/840/840				246/840/840			
	Packed unit	Height/Width/Depth	mm	220/882/882				260/882/882			
Weight	Unit		kg	18	19	21	24				
	Packed unit		kg	20	21	23	26				
Decoration panel	Model			BYCQ140D7GFW1 - auto cleaning panel with fine mesh filter							
	Colour			Pure White (RAL 9010)							
	Dimensions	HeightxWidthxDepth	mm	130x950x950							
	Weight			10.3							
Decoration panel 2	Model			BYCQ140D7W1W - full white							
	Colour			Pure White (RAL 9010)							
	Dimensions	HeightxWidthxDepth	mm	50x950x950							
	Weight			5.4							
Decoration panel 3	Model			BYCQ140D7GW1 - auto cleaning panel							
	Colour			Pure White (RAL 9010)							
	Dimensions	HeightxWidthxDepth	mm	130x950x950							
	Weight			10.3							
Decoration panel 4	Model			BYCQ140D7W1 - white with grey louvers							
	Colour			Pure White (RAL 9010)							
	Dimensions	HeightxWidthxDepth	mm	50x950x950							
	Weight			5.4							
Heat exchanger	Inside length		mm	2,134			2,090				
	Outside length		mm	2,181			2,184				
	Rows	Quantity		2			3				
	Fin pitch		mm	1.20							
	Passes	Quantity		4	6	12	14				
	Face area		m <sup>2</sup>	0.278	0.366	0.371	0.464				
	Stages	Quantity		9	12			15			
	Empty tubeplate hole		Quantity		0						
	Tube type			Ø5 HI-XA							
	Fin	Type		Cross fin coil (multi slit fins and hi-XA tubes)							
	Air filter	Type			Resin net						
Fan	Type			Turbo fan							
	Quantity			1							
	Air flow rate	Cooling	High	m <sup>3</sup> /min	12.5	12.6	13.6	15.3	22.8	26.0	
				cfm	441	445	480	540	805	918	
			Medium	m <sup>3</sup> /min	10.6 (1)	10.7 (1)	11.2 (1)	12.5 (1)	17.6 (1)	19.2 (1)	
		cfm		374	378	396	441	622	678		
		Low	m <sup>3</sup> /min	8.7			9.3	12.4			
			cfm	307			328	438			
	Heating	High	m <sup>3</sup> /min	13.9	12.6	13.6	15.0	22.8	26.0		
			cfm	491	445	480	530	805	918		
		Medium	m <sup>3</sup> /min	11.6 (1)	10.7 (1)	11.2 (1)	12.1 (1)	17.6 (1)	19.2 (1)		
cfm			410	378	396	427	622	678			
Low		m <sup>3</sup> /min	9.3	8.7			9.1	12.4			
		cfm	328	307			321	438			
Fan motor	Model			ARW5202DK				EHDS10CDK			
	Speed	Steps		3							
	Output	High	W	48				106			

## 2 Specifications

2

2-1 Technical Specifications				FCAG35A	FCAG50A	FCAG60A	FCAG71A	FCAG100A	FCAG125A	FCAG140A
Sound power level	Cooling		dBA	49		51		54	58	
	Heating		dBA	49		51		54	58	
Sound pressure level	Cooling	High/Medium/Low	dBA	31/29 (1)/27		33/31 (1)/28	35/31 (1)/28	37/33 (1)/29		41/35 (1)/29
	Heating	High/Medium/Low	dBA	31/29/27		33/31/28		37/33/29		41/35/29
Control systems	Infrared remote control			BRC7FA532F						
	Wired remote control			BRC1D528 / BRC1E53A7 / BRC1E53B7 / BRC1E53C7						
Refrigerant	Type			R-32 / R-410A						
Piping connections	Sound absorbing insulation			Foamed polyurethane						
	Liquid	Type/OD	mm	Flare connection/6,35			Flare connection/9,52			
	Gas	Type/OD	mm	Flare connection/9.52	Flare connection/12.70		Flare connection/15.90			
	Drain			VP25 (O.D. 32 / I.D. 25)						
	Heat insulation			Foamed polystyrene / Foamed polyethylene						

- Standard Accessories : Operation manual; Quantity : 1;
- Standard Accessories : Installation manual; Quantity : 1;
- Standard Accessories : Drain hose; Quantity : 1;
- Standard Accessories : Clamp for drain hose; Quantity : 1;
- Standard Accessories : Washer for hanger bracket; Quantity : 8;
- Standard Accessories : Screws; Quantity : 4;
- Standard Accessories : Installation guide; Quantity : 2;
- Standard Accessories : Insulation for fitting; Quantity : 2;
- Standard Accessories : Sealing pads; Quantity : 4;
- Standard Accessories : Drain sealing pad; Quantity : 1;
- Standard Accessories : Wire clamp materials; Quantity : 7;

2-2 Electrical Specifications				FCAG35A	FCAG50A	FCAG60A	FCAG71A	FCAG100A	FCAG125A	FCAG140A
Power supply	Phase			1~						
	Frequency		Hz	50/60						
	Voltage		V	220-240/220						

### Notes

(1) This option is intended exclusively for usage in fine dust environments (clothing shops). Do not use this option in high humidity and/or greasy environments.

The sound power level is an absolute value indicating the power which a sound source generates.

The BYCQ140D7W1W has white insulations. Be informed that formation of dirt on white insulation is visibly stronger and that it is consequently not advised to install the BYCQ140D7W1W decoration panel in environments exposed to concentrations of dirt.

BYCQ140D7W1: pure white standard panel with grey louvers; BYCQ140D7W1W: pure white standard panel with white louvers; BYCQ140D7GW1: pure white auto cleaning panel.

# 3 Options

## 3 - 1 Options

### FCAG-A

Option kit	Product name	Availability	
		SA	
		FCAG35AVEB FCAG50AVEB FCAG60AVEB FCAG71AVEB FCAG100AVEB FCAG125AVEB FCAG140AVEB	FCAHG71GVEB FCAHG100GVEB FCAHG125GVEB FCAHG140GVEB
Decoration panel - Standard	BYCQ140D7W1	✓	✓
Decoration panel - White	BYCQ140D7W1W (3)	✓	✓
Self-cleaning decoration panel	BYCQ140D7GW9/BYCQ140D7GFW9 (5)(6)(11)	✓	✓
Long-life replacement filter	KAFP551K160	✓	✓
Chamber [part of fresh air intake kit (20% fresh air)]	KDDQ558140-1 (7)(8)	✓	✓
Diffuser from chamber to duct [part of fresh air intake kit (20% fresh air)]	KDDQ558140-2 (7)(8)	✓	✓
Air discharge outlet sealing member	KDBHQ558140 (7)	✓	✓
Sensor kit	BRVQ140A7	✓	✓
Wireless remote control	BRC7FA53ZF (7)	✓	✓
Wired remote control	BRC1D52B (4)	✓	✓
Wired remote control	BRC1E53A7 (12) / BRC1E53B7 (13) / BRC1E53C7 (14) (15)	✓	✓
Simplified remote control (with operation mode selector button)	BRC2E52C (9) (15)	✓	✓
Simplified remote control (without operation mode selector button)	BRC3E52C (9) (15)	✓	✓
Wiring adaptor for electrical appendices 1	KRP1BA57 (2)(7)	✓	✓
Wiring adaptor for electrical appendices 2	KRP4AA53 (2)(7)	✓	✓
Wiring adaptor (hour meter)	EKRP1C11 (2)(7)	✓	✓
Remote sensor	KRC501-4B	✓	✓
Installation box for adaptor PCB	KRP1H98 (7)	✓	✓
Central remote control	DCS302CA51	✓	✓
Unified ON/OFF controller	DCS301BA51	✓	✓
Electrical box with earth terminal (2 blocks)	KB212AA	✓	✓
Electrical box with earth terminal (3 blocks)	KB311AA	✓	✓
Schedule timer	DST301BA51	✓	✓
Digital input adaptor	BRP7A53 (16)	✓	✓

**Notes**

- (1): All options are kits
- (2): Requires installation box for adaptor PCB
- (3): This option has white insulation.  
Be aware that dirt formation is more easily visible on white insulation.  
It is recommended not to install this option in environments with a high concentration of dirt.
- (4): Not recommended because of its limited functionality.
- (5): To be able to control option BYCQ140D7GW9/BYCQ140D7GFW9, controller BRC1E is required.
- (6): Option BYCQ140D7GW9/BYCQ140D7GFW9 cannot be used with VRV IV-S, multi, and non-inverter split outdoor units.
- (7): This option cannot be combined with BYCQ140D7GW9/BYCQ140D7GFW9.
- (8): Both parts of the fresh air intake kit are required for each unit.
- (9): Included languages are:  
Language pack 1: English, German, French, Dutch, Spanish, Italian, and Portuguese.  
With PC cable EKPPCCAB3 in combination with the Updater PC software, you can additionally change the language to:  
Language pack 2: English, Bulgarian, Croatian, Czech, Hungarian, Romanian, and Slovenian.  
Language pack 3: English, Greek, Polish, Russian, Serbian, Slovak, and Turkish.
- (10): Only possible in combination with remote control BRC2/3E52C, BRC1E53A/B/C7.
- (11): This option is intended exclusively for use in fine dust environments (e.g. clothing shops). Do not use it in environments that are greasy, or have high humidity.
- (12): Included languages are: English, German, French, Italian, Spanish, Portuguese, and Dutch.
- (13): Included languages are: English, Czech, Croatian, Hungarian, Slovenian, Romanian, and Bulgarian.
- (14): Included languages are: English, Russian, Greek, Turkish, Polish, Albanian, and Slovak.
- (15): Language pack 3 of controller BRC1E53C7 is different from that of controller BRC2/3E52C7.

**3D106134A**

# 4 Dimensional drawings

## 4 - 1 Dimensional Drawings with Accessories

4

### FCAG-A

**Notes**

1. Location of nameplate  
The unit nameplate is located on the control box cover.  
The decoration panel nameplate is located on the piping-side panel frame, under the corner cover.
2. When installing optional accessories, refer to their respective documentation.
3. Make sure the distance between the ceiling and the cassette does not exceed 35mm.
4. The maximum ceiling opening is 910mm.
5. When the conditions in the ceiling exceed 30°C ambient temperature and 80% relative humidity, or when fresh air is inducted into the ceiling, additional insulation is required (polyethylene foam, thickness ≥10mm).
6. When installing a sensor kit, there will be a sensor on this location. For details, see the drawing of the sensor kit.
7. When installing a wireless controller, there will be a receiver on this location. For details, see the drawing of the wireless controller.

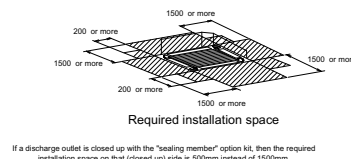
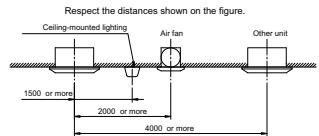
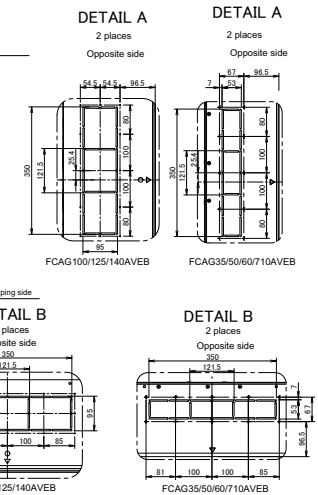
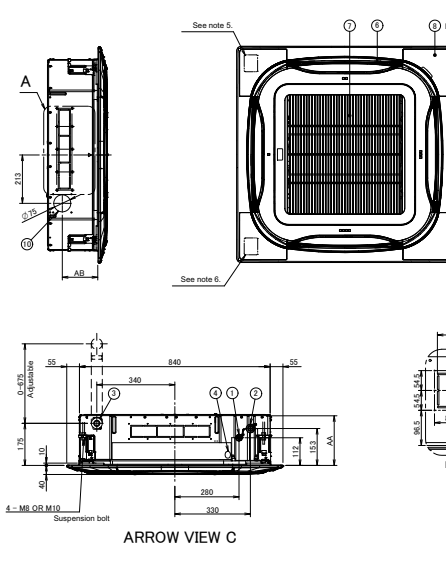
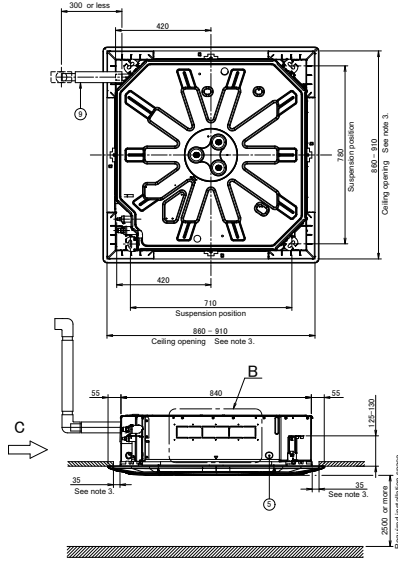

Item	Name
①	Liquid pipe connection port
②	Gas pipe connection port
③	Drain pipe connection
④	Power supply wiring intake
⑤	Transmission wiring intake hole
⑥	Air discharge outlet
⑦	Air suction grille
⑧	Corner decoration cover
⑨	Drain hose
⑩	Knockout hole

2D106292

### FCAG-A

**Notes**

1. Location of nameplate  
The unit nameplate is located on the control box cover.  
The decoration panel nameplate is located on the piping-side panel frame, under the corner cover.
2. When installing optional accessories, refer to their respective documentation.
3. Make sure the distance between the ceiling and the cassette does not exceed 35mm.
4. The maximum ceiling opening is 910mm.
5. When the conditions in the ceiling exceed 30°C ambient temperature and 80% relative humidity, or when fresh air is inducted into the ceiling, additional insulation is required (polyethylene foam, thickness ≥10mm).
6. When installing a sensor kit, there will be a sensor on this location. For details, see the drawing of the sensor kit.
7. When installing a wireless controller, there will be a receiver on this location. For details, see the drawing of the wireless controller.

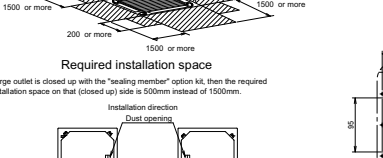
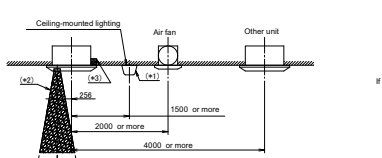
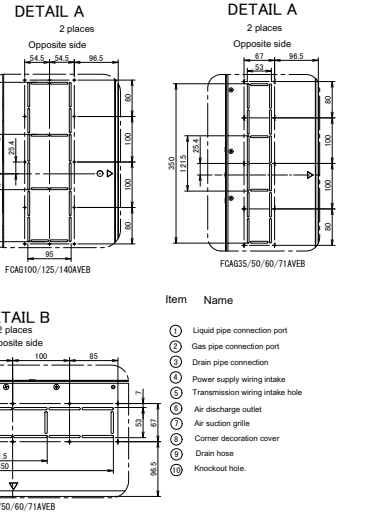
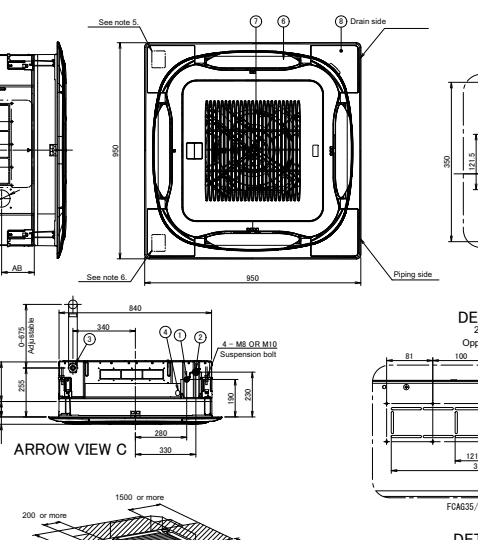
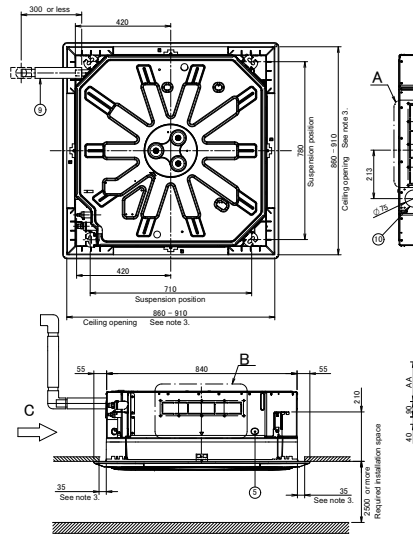

Item	Name
①	Liquid pipe connection port
②	Gas pipe connection port
③	Drain pipe connection
④	Power supply wiring intake
⑤	Transmission wiring intake hole
⑥	Air discharge outlet
⑦	Air suction grille
⑧	Corner decoration cover
⑨	Drain hose
⑩	Knockout hole

2D106293

6



# 4 Dimensional drawings

## 4 - 1 Dimensional Drawings with Accessories

**FCAG-A**

Remote control dimensions

Transmitter

157

62

17.5

ON/OFF

POWER

UP

FAN

Receiver

Receiver detail

Receiver detail

Installation methods  
Installation to wall surface

Wireless remote control

Remote control holder

Decorations panel

Decorations panel

Drain side

Piping side

Sensor kit	BRC7FA532F
Decorations panel	BYCQ140D7W1(W)

**3D106316**

# 4 Dimensional drawings

## 4 - 1 Dimensional Drawings with Accessories

### FCAG-A

4

Sensor kit Installation methods

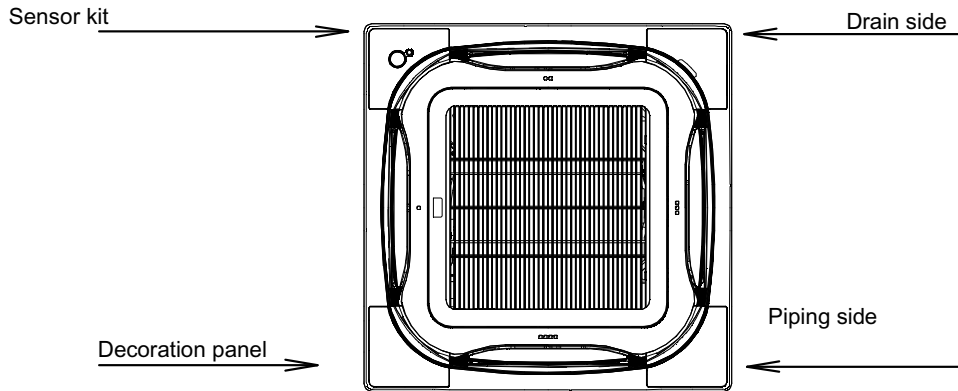

Sensor kit	BRYQ140A7
Decoration panel	BYCQ140D7W1(W)

Sensor kit Installation methods

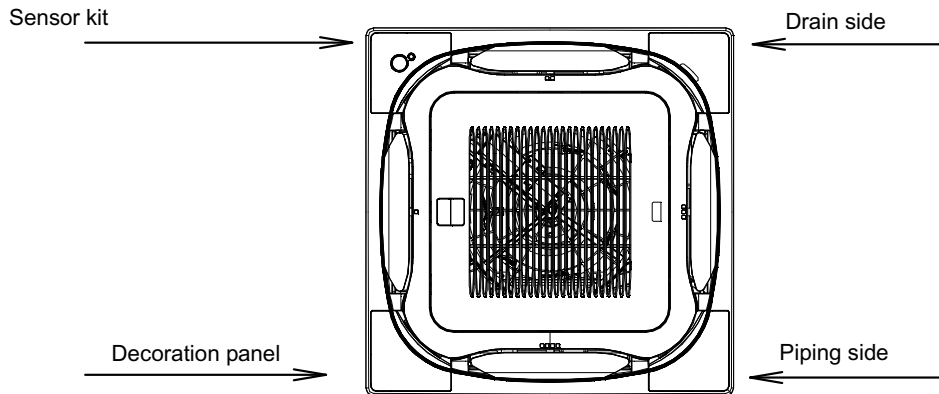

Sensor kit	BRYQ140A7
Decoration panel	BYCQ140D7GW9/BYCQ140D7GFW9

4D106294

# 4 Dimensional drawings

## 4 - 2 Dimensional Drawings with Fresh Air Intake

### FCAG-A

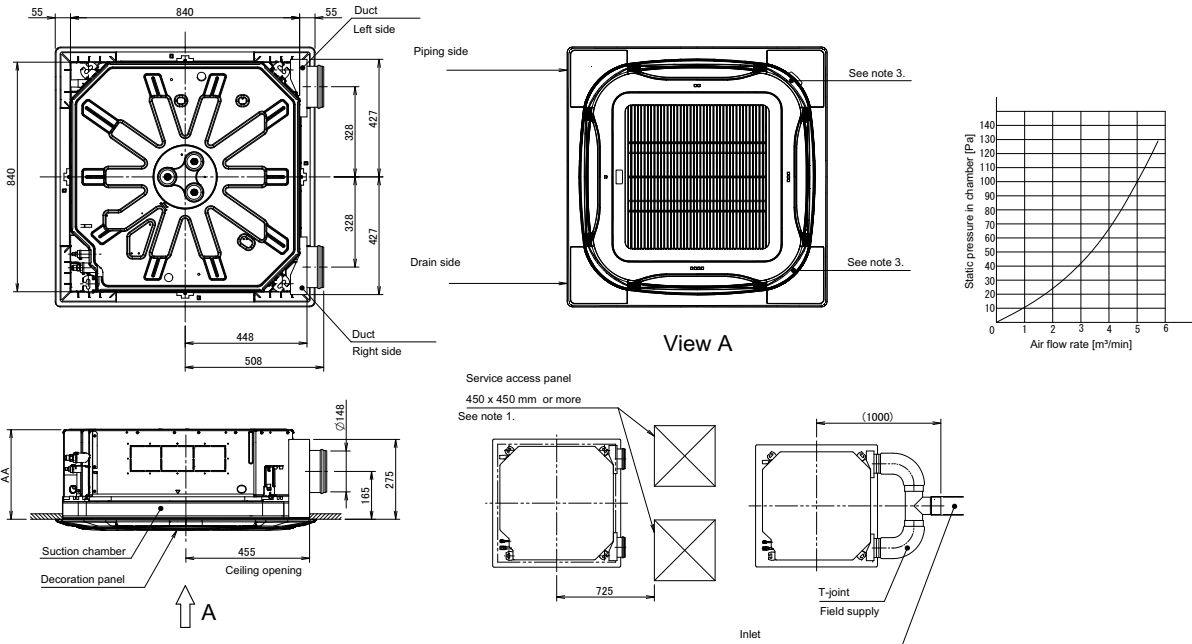

- Notes
1. When installing a fresh air intake kit, provide a service access panel.
  2. Field construction
  3. This corner discharge outlet needs to be closed.
  4. When installing a duct fan, use a wiring adapter to link the duct fan to the fan of the indoor unit.
  5. The intake air flow rate is recommended to be ≤20% of the air flow rate at high fan speed.  
If the intake air flow rate is too large, the operating sound may increase, and the detection of the indoor unit suction temperature may be affected.
  6. This indicates the distance between the T-joint inlet and the indoor unit inlet when the T-tube is connected.

**3D106327**

# 5 Centre of gravity

## 5 - 1 Centre of Gravity

### FCAG-A

5

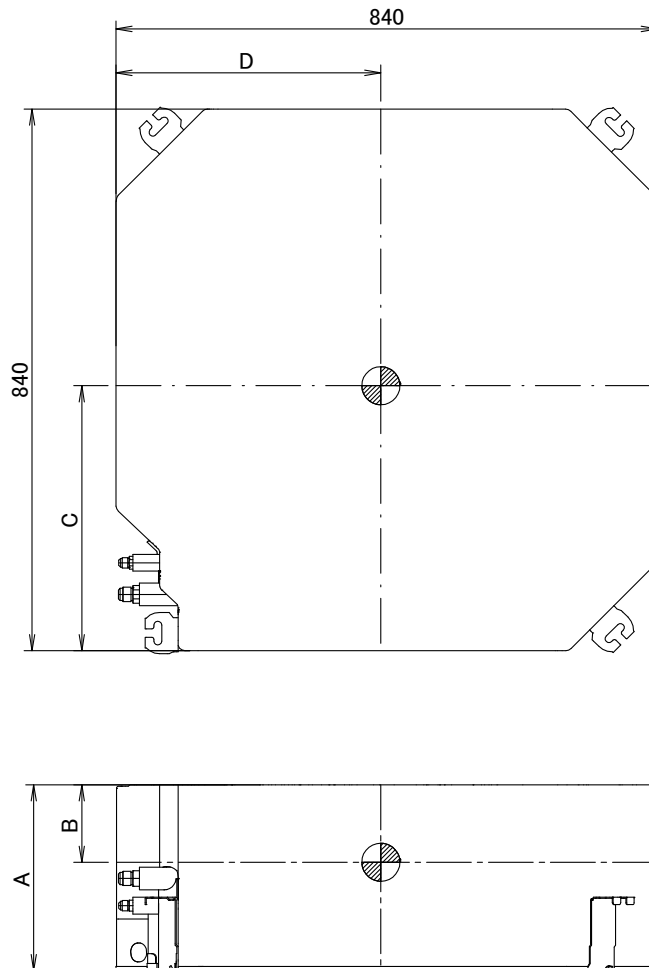

Model	A	B	C	D
FCQG35~71FVEB, FXFQ20~63AVEB	204	60	409	358
FCQG100~140FVEB, FXFQ80~100AVEB	246	90	411	411
FCQHG71~140FVEB, FXFQ125AVEB	288	120	420	420
FCAHG71~140FVEB	288	120	420	420
FCAG35~71AVEB	204	60	409	358
FCAG100~140AVEB	246	90	411	411

4D077032C

# 6 Piping diagrams

## 6 - 1 Piping Diagrams

### FCAG-A

Refrigerant flow  
 Cooling ———→  
 Heating - - - ->

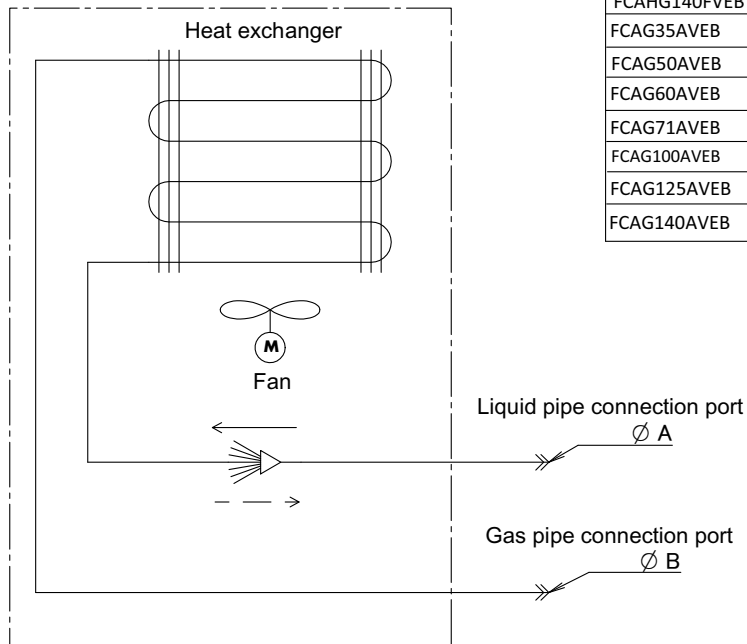

Model	A	B		
FCQG35FVEB	6.35	9.52		
FCQG50FVEB		12.7		
FCQG60FVEB				
FCQG71FVEB	9.52	15.9		
FCQG100FVEB				
FCQG125FVEB				
FCQG140FVEB				
FCQHG71FVEB				
FCQHG100FVEB				
FCQHG125FVEB				
FCQHG140FVEB	9.52	15.9		
FCAHG71FVEB				
FCAHG100FVEB				
FCAHG125FVEB				
FCAHG140FVEB				
FCAG35AVEB			6.35	9.52
FCAG50AVEB			6.35	12.7
FCAG60AVEB				
FCAG71AVEB	9.52	15.9		
FCAG100AVEB				
FCAG125AVEB				
FCAG140AVEB				

4D076993B

# 7 Wiring diagrams

## 7 - 1 Wiring Diagrams - Single Phase

7

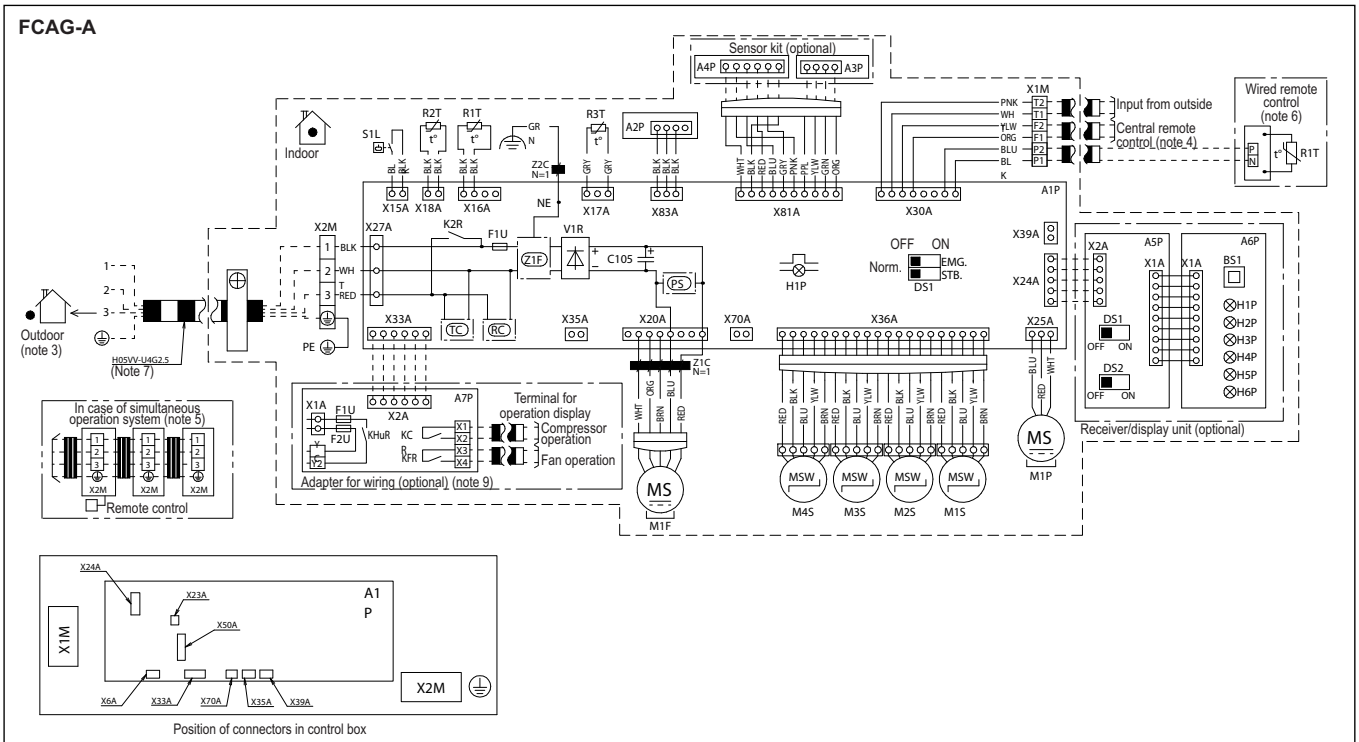

Position of connectors in control box

Indoor unit	
A1P	Main PCB
C105	Capacitor
F1U	Fuse (T, 3.15A, 250V)
DS1	Dip switch on PCB
H1P	Flashing lamp (service monitor green)
K2R	Magnetic relay (drain pump)
M1P	Motor (drain pump)
M1F	Motor (indoor fan)
M1S-M4S	Motor (swing blade)
R1T	Thermistor (air)
R2T, R3T	Thermistor (coil)
V1R	Diode bridge
X1M	Terminal block (remote control)
X2M	Terminal block (power supply)
Z1C, Z2C	Ferrite core
Z1F	Noise filter
PS	Power supply circuit
RC	Signal receiver circuit
TC	Signal transmission circuit
NE	Noiseless earth
Sensor kit	
A3P, A4P	Sensor kit PCB
Infrared remote control (receiver/display unit)	
A5P	Receiver PCB
A6P	Display PCB
BS1	Push button (on/off)
H1P	Pilot lamp (on: red)

H2P	Pilot lamp (timer: green)
H3P	Pilot lamp (filter sign: red)
H4P	Pilot lamp (defrost: orange)
H5P	Pilot lamp (element cleaning: red)
H6P	Pilot lamp (timer: green)
DS1	Dip switch (main/sub)
DS2	Dip switch (wireless address set)
Adapter for wiring	
A7P	Adapter PCB
F1U	Fuse (5A, 250V)
F2U	Fuse (5A, 250V)
KHuR	Magnetic relay
KCR	Magnetic relay
KFR	Magnetic relay
Connectors for optional parts	
X1A	Connector (power supply for option PCB)
X2A	Connector (sensor kit)
X24A	Connector (infrared remote control)
X33A	Connector (adapter for wiring)
X35A	Connector (auto clean panel)
X39A	Connector (auto clean panel)
X70A	Connector (auto clean panel)
X81A	Sensor kit
Wired remote control	
R1T	Thermistor (air)
Humidity sensor	
A2P	Sensor PCB

### NOTES

- : terminal block, □○□: connector, -|-|-: field wiring
- In case of simultaneous operation indoor unit system, see the indoor unit wiring only.
- For details, see wiring diagram attached to the outdoor unit.
- In case of using central remote control, connect it to the unit in accordance with the attached installation manual.
- In case of simultaneous operation system, connected quantity of the indoor units varies according to the connected outdoor unit.
- In case of main/sub changeover, see installation manual attached to the remote control.
- Shown only in case of protection piping, use H07RN-F in case of no protection.
- X35A, X39A, X70A are connected when optional accessories are being used (auto clean panel), see wiring diagram of this accessory.
- Connect power of adapter for wiring to terminal block (X2M) of indoor unit directly.
- Colors: BLK: Black, RED: Red, BLU: Blue, WHT: White, YLW: Yellow, GRN: Green, BRN: Brown, PPL: Purple, PNK: Pink, ORG: Orange.

3D109572

# 8 Sound data

## 8 - 1 Sound Pressure Spectrum

### FCAG35A

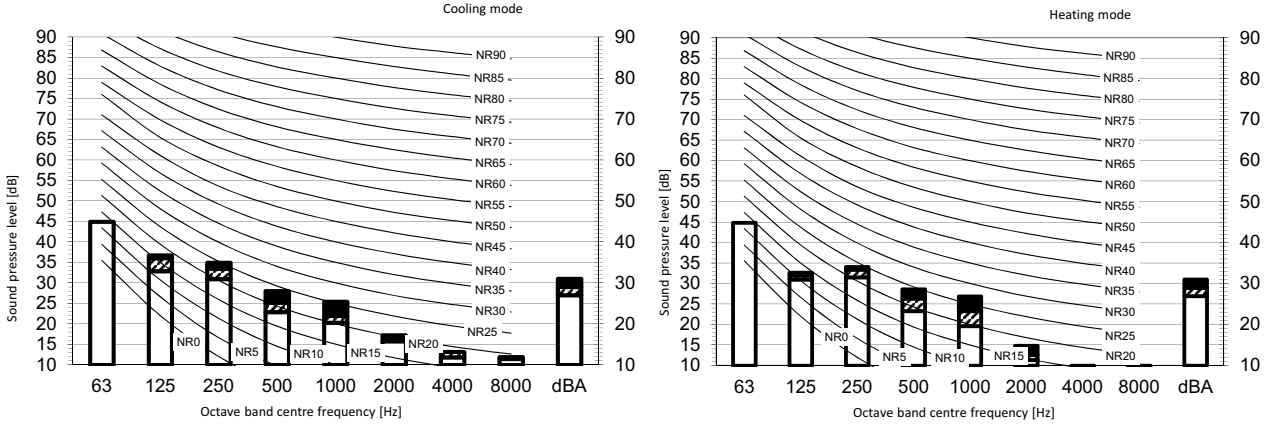

Legend  
dBA = A-weighted sound pressure level (A scale according to IEC).

A Scale Fan speed  
B High  
C Medium  
D Low  
Location of microphone

Cooling Total dB				Heating Total dB			
A	B	C	D	A	B	C	D
dBA	31	29	27	dBA	31	29	27

- Notes
1. Operating conditions: power source 220-240 V/220 V 50/60 Hz; JIS standard
  2. Background noise already taken into account.
  3. Operating noise varies depending on operation and ambient conditions.
  4. The operation noise measuring method is in accordance with JISC9612.
  5. Measuring location: anechoic chamber

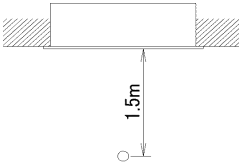

3D110165

### FCAG50A

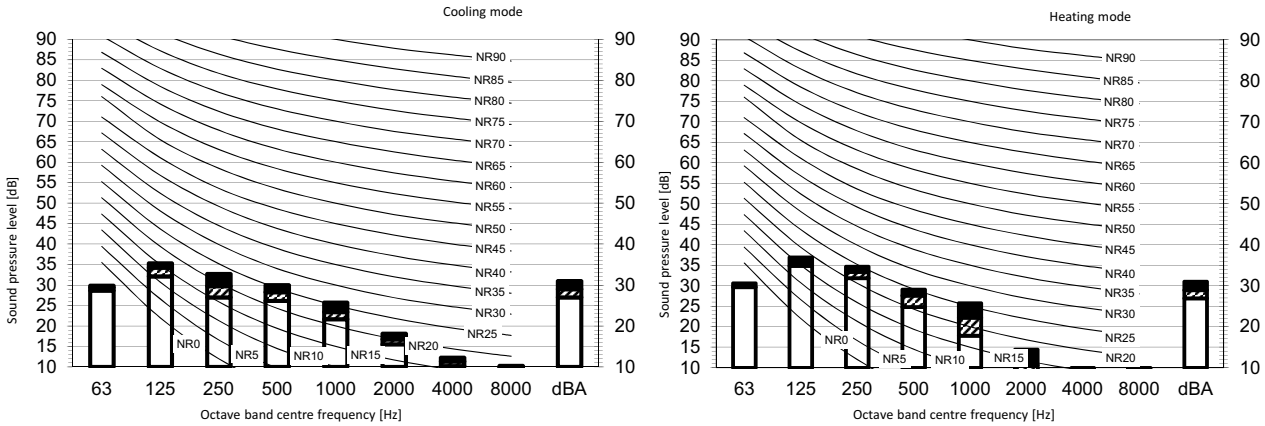

Legend  
dBA = A-weighted sound pressure level (A scale according to IEC).

A Scale Fan speed  
B High  
C Medium  
D Low  
Location of microphone

Cooling Total dB				Heating Total dB			
A	B	C	D	A	B	C	D
dBA	31	29	27	dBA	31	29	27

- Notes
1. Operating conditions: power source 220-240 V/220 V 50/60 Hz; JIS standard
  2. Background noise already taken into account.
  3. Operating noise varies depending on operation and ambient conditions.
  4. The operation noise measuring method is in accordance with JISC9612.
  5. Measuring location: anechoic chamber

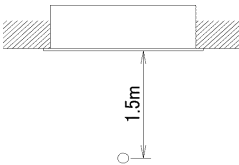

3D110174

# 8 Sound data

## 8 - 1 Sound Pressure Spectrum

8

### FCAG60A

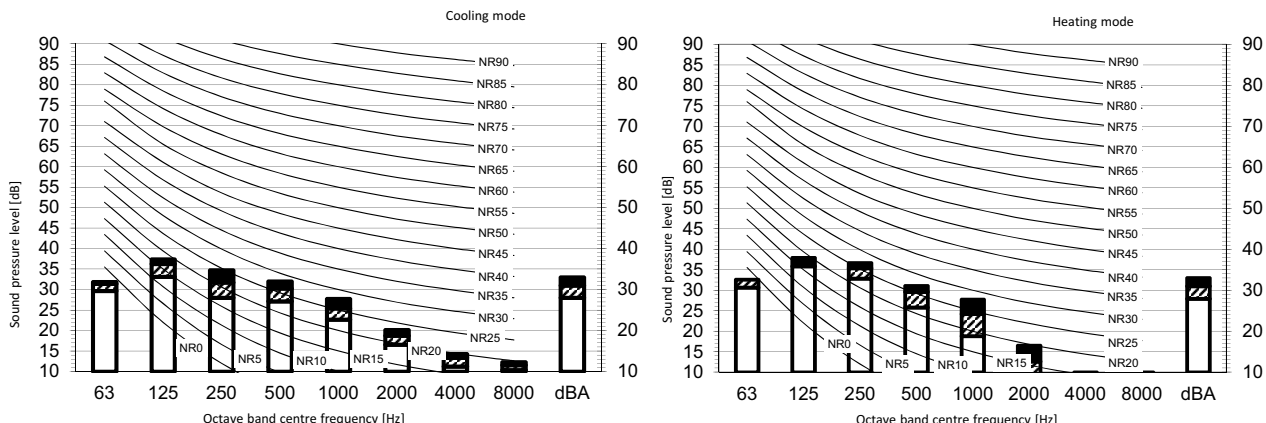

Legend  
dBA = A-weighted sound pressure level (A scale according to IEC).

A Scale Fan speed

B High

C Medium

D Low

Location of microphone

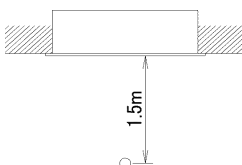

Cooling Total dB				Heating Total dB			
A	B	C	D	A	B	C	D
dBA	33	31	28	dBA	33	31	28

- Notes
- Operating conditions: power source 220-240 V/220 V 50/60 Hz; JIS standard
  - Background noise already taken into account.
  - Operating noise varies depending on operation and ambient conditions.
  - The operation noise measuring method is in accordance with JISC9612.
  - Measuring location: anechoic chamber

3D110175

### FCAG71A

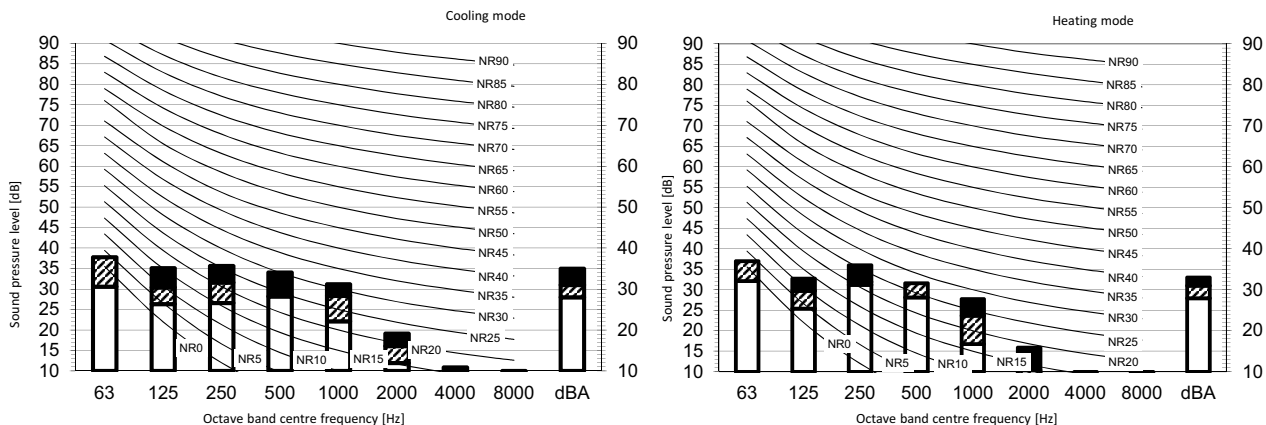

Legend  
dBA = A-weighted sound pressure level (A scale according to IEC).

A Scale Fan speed

B High

C Medium

D Low

Location of microphone

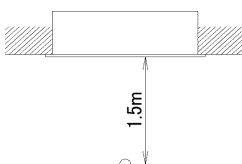

Cooling Total dB				Heating Total dB			
A	B	C	D	A	B	C	D
dBA	35	31	28	dBA	33	31	28

- Notes
- Operating conditions: power source 220-240 V/220 V 50/60 Hz; JIS standard
  - Background noise already taken into account.
  - Operating noise varies depending on operation and ambient conditions.
  - The operation noise measuring method is in accordance with JISC9612.
  - Measuring location: anechoic chamber

3D110176



# 8 Sound data

## 8 - 1 Sound Pressure Spectrum

### FCAG100A

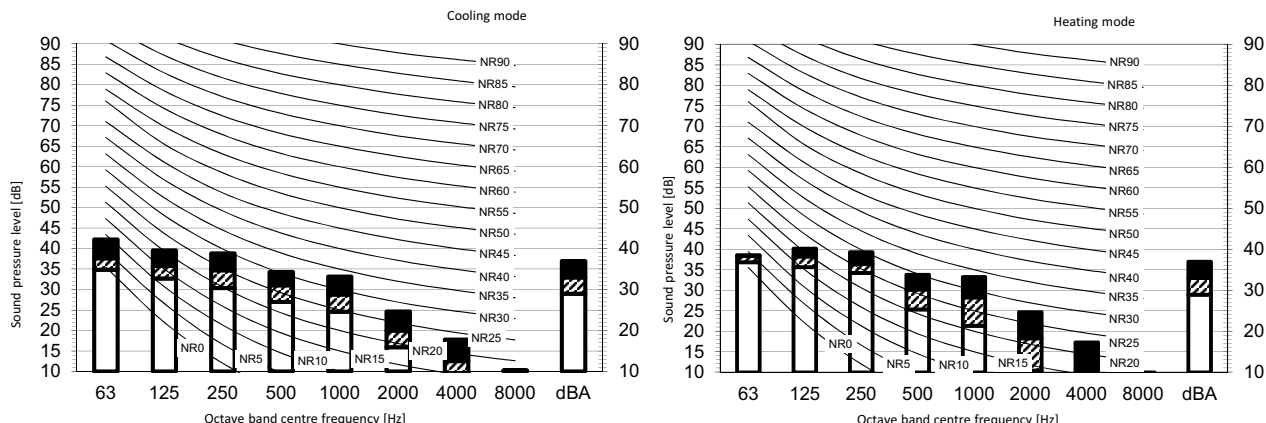

**Legend**

dBA = A-weighted sound pressure level (A scale according to IEC).

A Scale Fan speed

B High  
C Medium  
D Low

Location of microphone

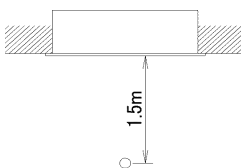

Cooling Total dB				Heating Total dB			
A	B	C	D	A	B	C	D
dBA	37	33	29	dBA	37	33	29

**Notes**

1. Operating conditions: power source 220-240 V/220 V 50/60 Hz; JIS standard
2. Background noise already taken into account.
3. Operating noise varies depending on operation and ambient conditions.
4. The operation noise measuring method is in accordance with JISC9612.
5. Measuring location: anechoic chamber

3D110177

### FCAG125A

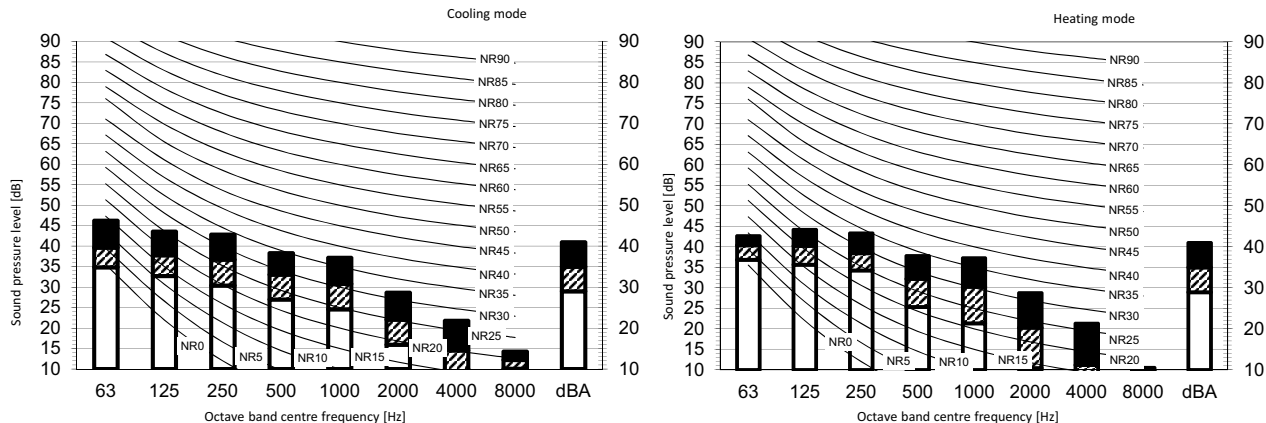

**Legend**

dBA = A-weighted sound pressure level (A scale according to IEC).

A Scale Fan speed

B High  
C Medium  
D Low

Location of microphone

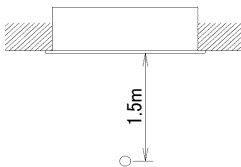

Cooling Total dB				Heating Total dB			
A	B	C	D	A	B	C	D
dBA	41	35	29	dBA	41	35	29

**Notes**

1. Operating conditions: power source 220-240 V/220 V 50/60 Hz; JIS standard
2. Background noise already taken into account.
3. Operating noise varies depending on operation and ambient conditions.
4. The operation noise measuring method is in accordance with JISC9612.
5. Measuring location: anechoic chamber

3D110178

# 8 Sound data

## 8 - 1 Sound Pressure Spectrum

8

### FCAG140A

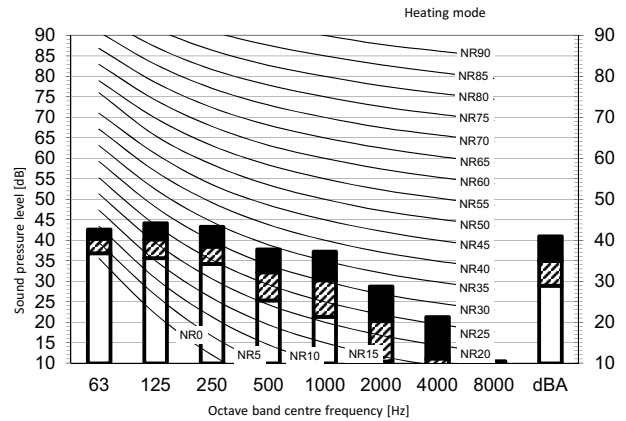
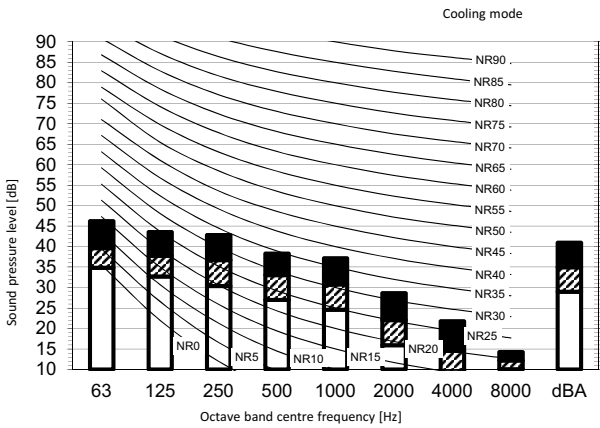

Legend  
dBA = A-weighted sound pressure level (A scale according to IEC).

A Scale Fan speed

- B High
- C Medium
- D Low

Location of microphone

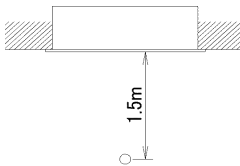

Cooling				Heating			
Total dB				Total dB			
A	B	C	D	A	B	C	D
dBA	41	35	29	dBA	41	35	29

Notes

1. Operating conditions: power source 220-240 V/220 V 50/60 Hz; JIS standard
2. Background noise already taken into account.
3. Operating noise varies depending on operation and ambient conditions.
4. The operation noise measuring method is in accordance with JISC9612.
5. Measuring location: anechoic chamber

3D110179

## 9 Air flow patterns

### 9 - 1 Air Flow Pattern - Cooling

# FCAG35A

#### Air velocity distribution (cooling)

Air flow direction: horizontal

Air discharge: all-round

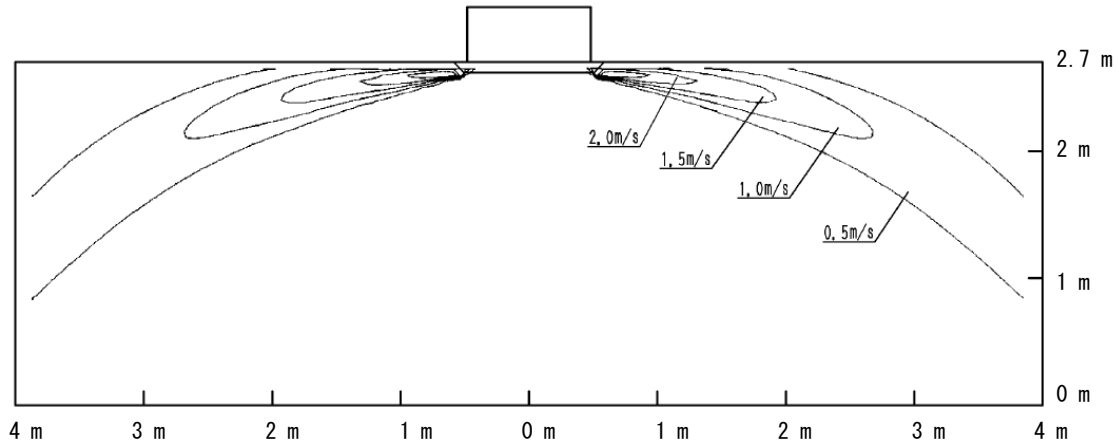

#### Air temperature distribution (cooling)

Air flow direction: horizontal

Air discharge: all-round

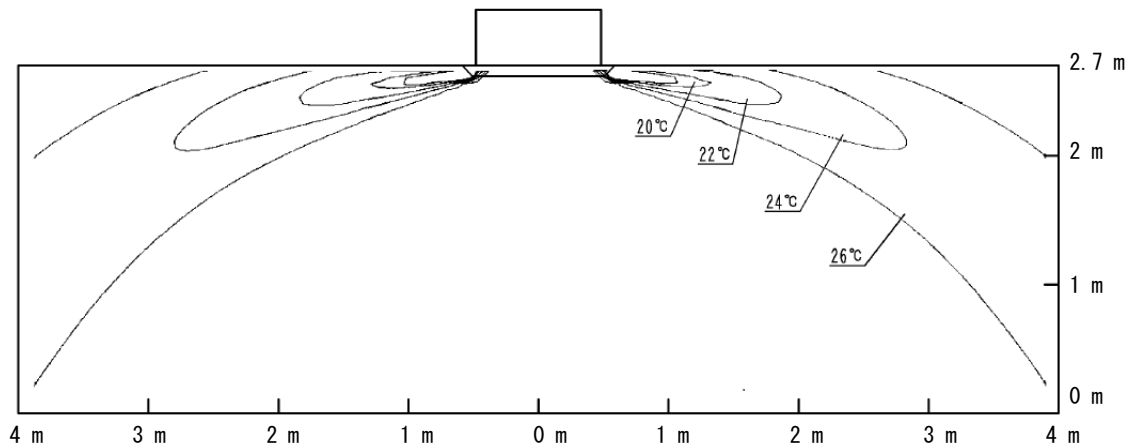

**4D106166**

# 9 Air flow patterns

## 9 - 1 Air Flow Pattern - Cooling

9

### FCAG50A

Air velocity distribution (cooling)

Air flow direction: horizontal

Air discharge: all-round

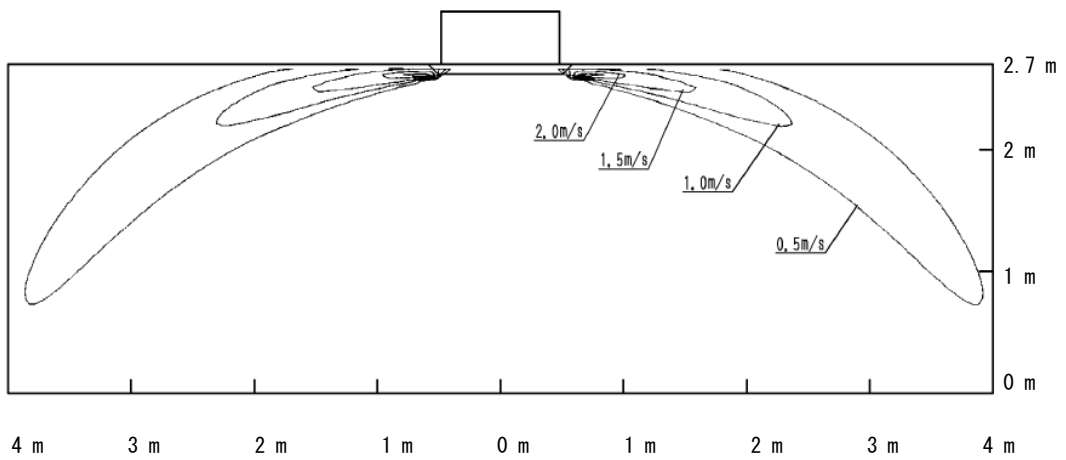

Air temperature distribution (cooling)

Air flow direction: horizontal

Air discharge: all-round

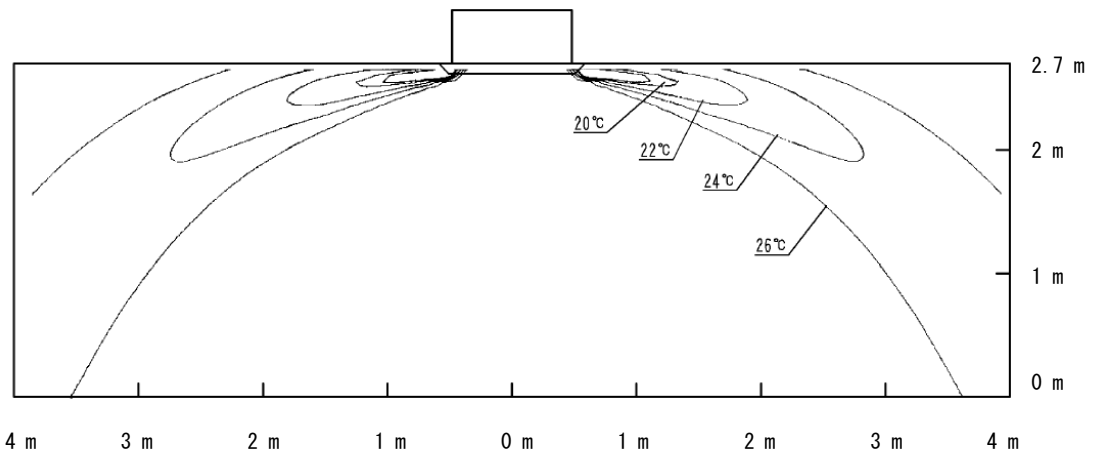

**4D106167**

## 9 Air flow patterns

### 9 - 1 Air Flow Pattern - Cooling

# FCAG60A

#### Air velocity distribution (cooling)

Air flow direction: horizontal

Air discharge: all-round

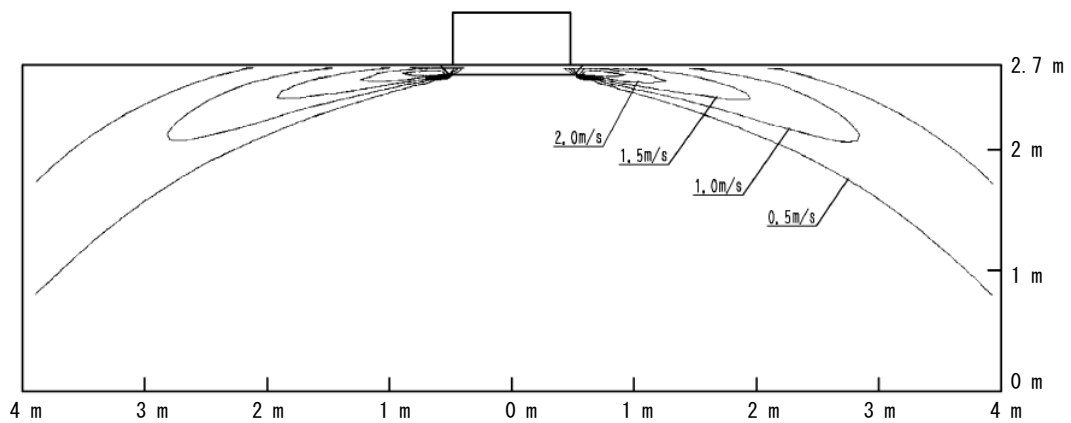

#### Air temperature distribution (cooling)

Air flow direction: horizontal

Air discharge: all-round

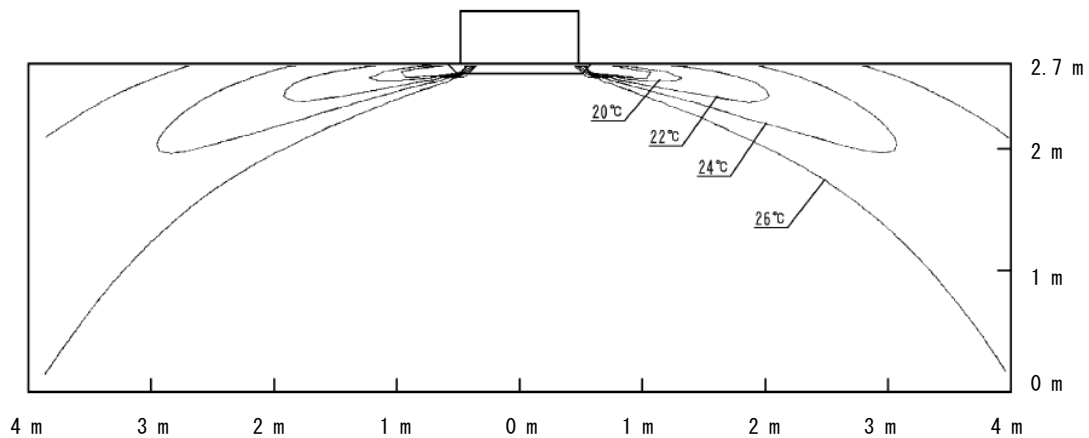

**4D106168**

# 9 Air flow patterns

## 9 - 1 Air Flow Pattern - Cooling

9

### FCAG71A

#### Air velocity distribution (cooling)

Air flow direction: horizontal

Air discharge: all-round

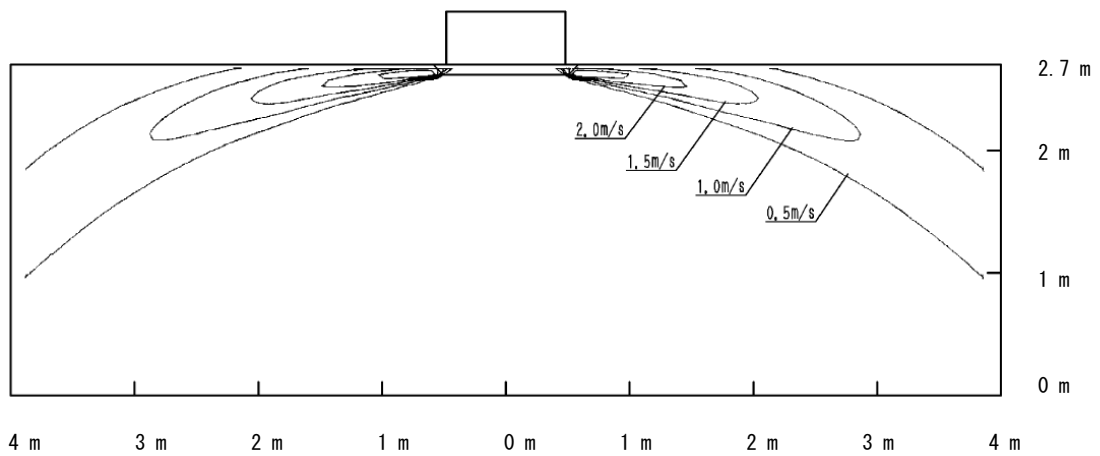

#### Air temperature distribution (cooling)

Air flow direction: horizontal

Air discharge: all-round

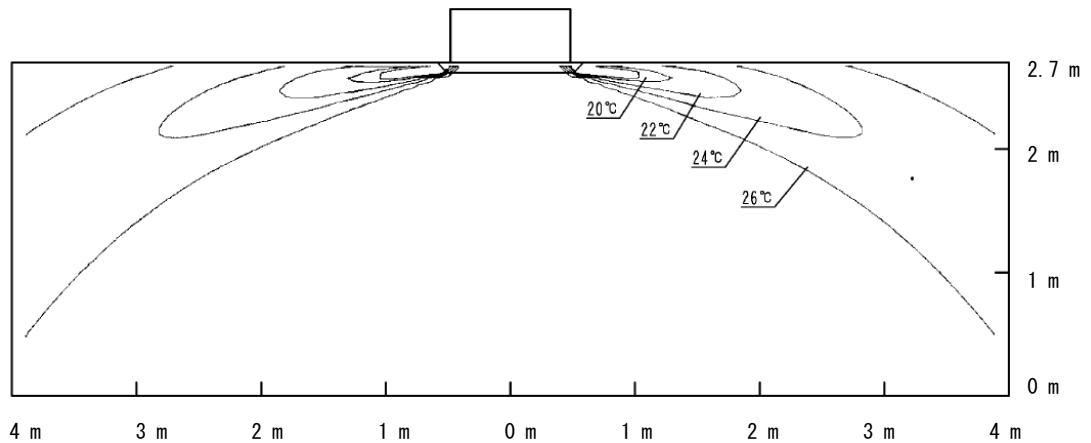

**4D106175**

## 9 Air flow patterns

### 9 - 1 Air Flow Pattern - Cooling

# FCAG100A

#### Air velocity distribution (cooling)

Air flow direction: horizontal

Air discharge: all-round

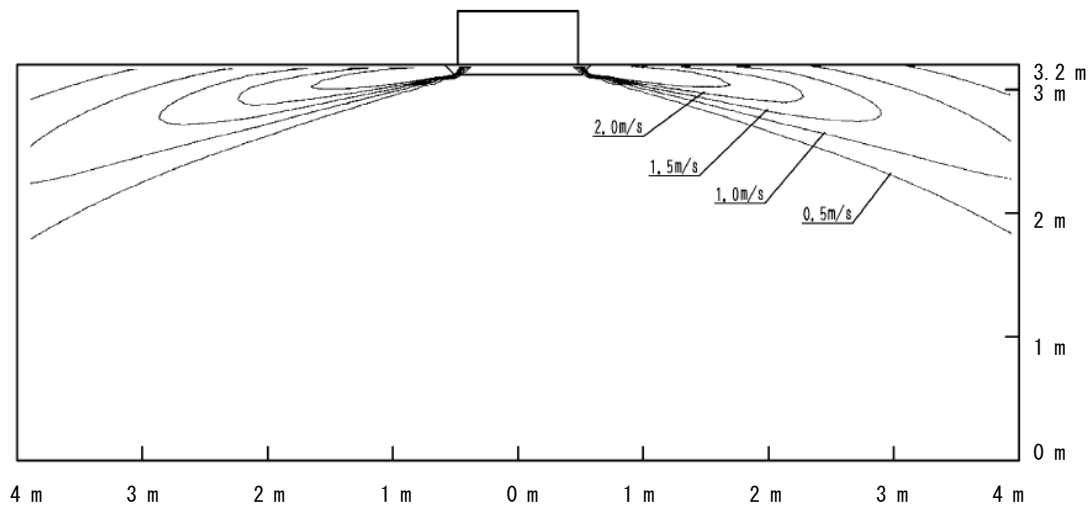

#### Air temperature distribution (cooling)

Air flow direction: horizontal

Air discharge: all-round

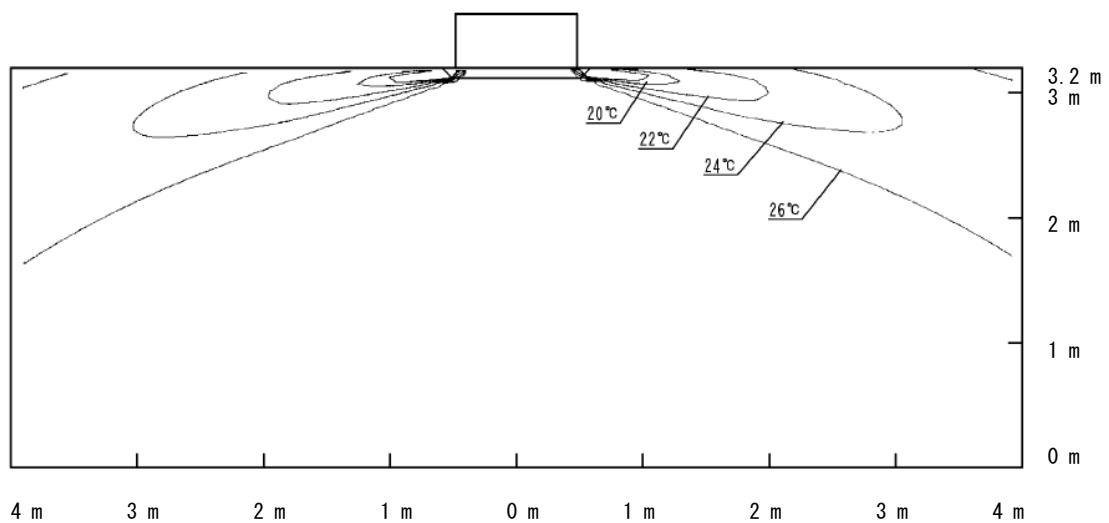

**4D106176**

# 9 Air flow patterns

## 9 - 1 Air Flow Pattern - Cooling

9

### FCAG125A

#### Air velocity distribution (cooling)

Air flow direction: horizontal

Air discharge: all-round

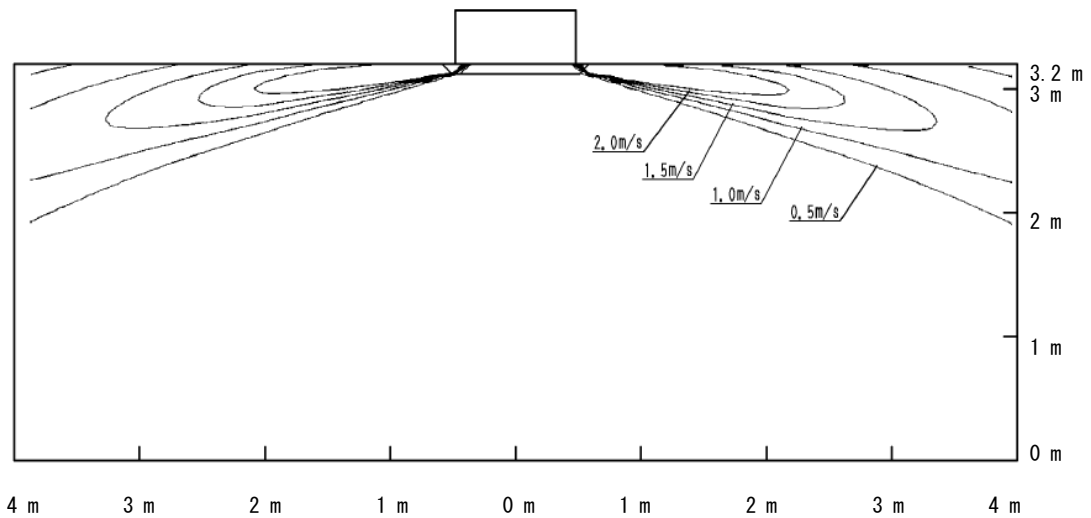

#### Air temperature distribution (cooling)

Air flow direction: horizontal

Air discharge: all-round

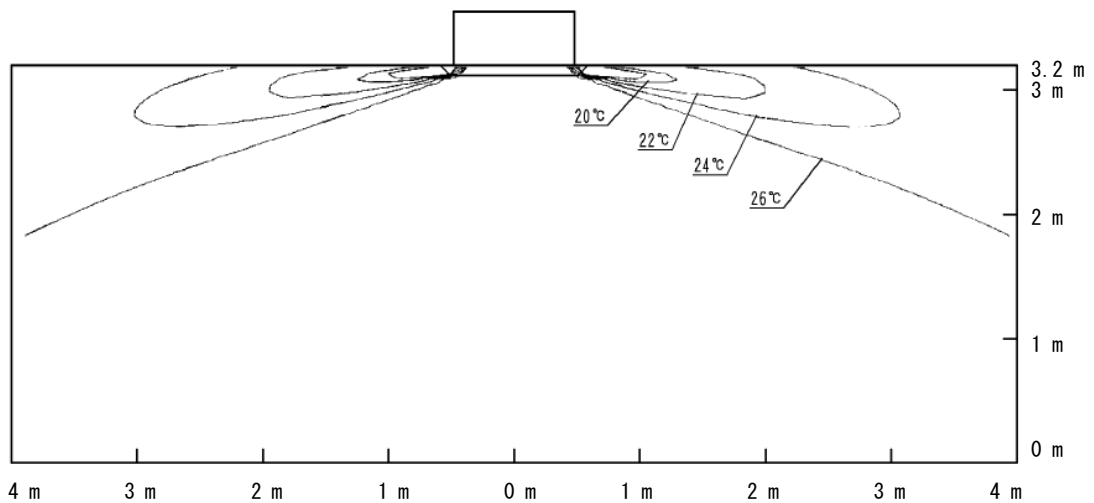

**4D106177**



## 9 Air flow patterns

### 9 - 1 Air Flow Pattern - Cooling

# FCAG140A

Air velocity distribution (cooling)

Air flow direction: horizontal

Air discharge: all-round

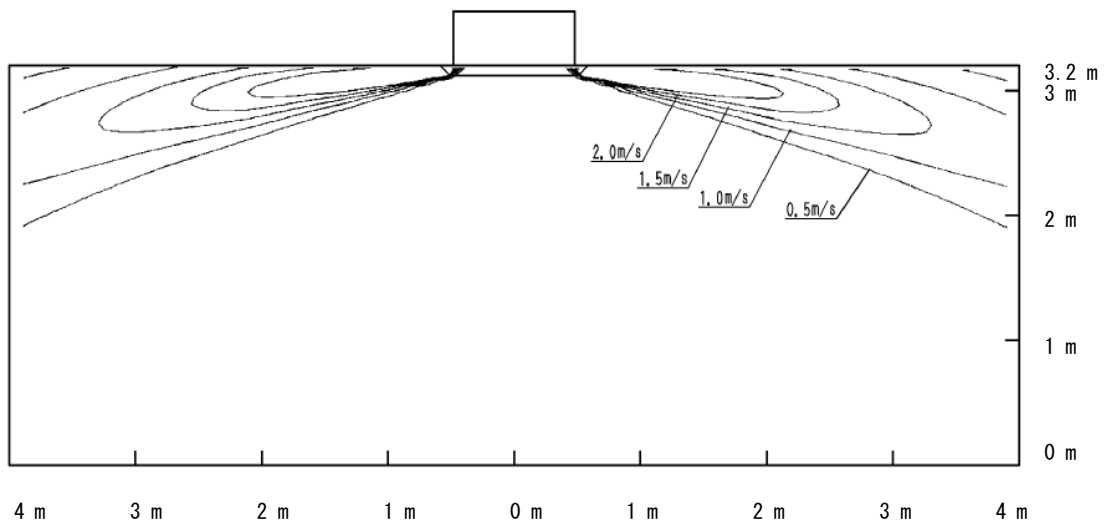

Air temperature distribution (cooling)

Air flow direction: horizontal

Air discharge: all-round

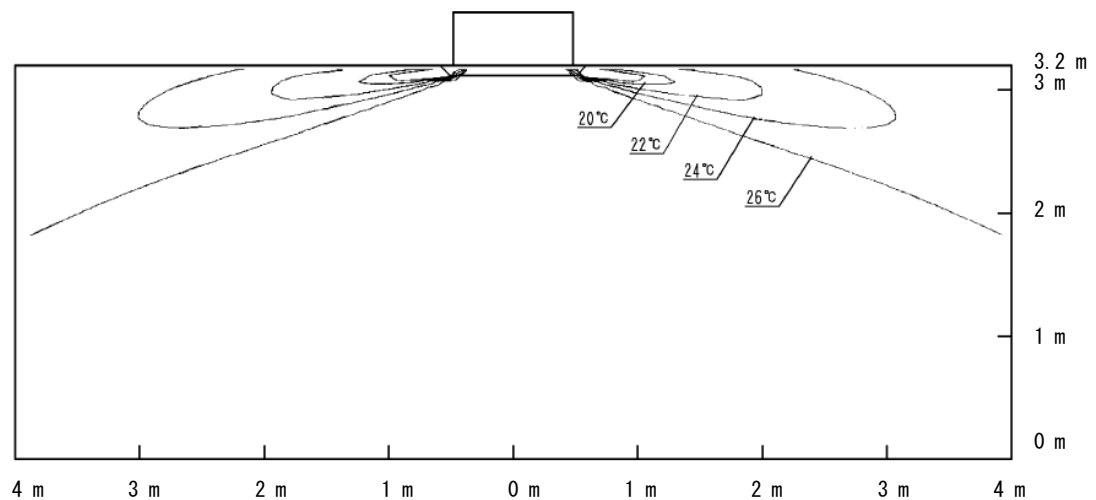

**4D106178**

# 9 Air flow patterns

## 9 - 2 Air Flow Pattern - Heating

9

### FCAG35A

#### Air velocity distribution (heating)

Air flow direction: horizontal

Air discharge: all-round

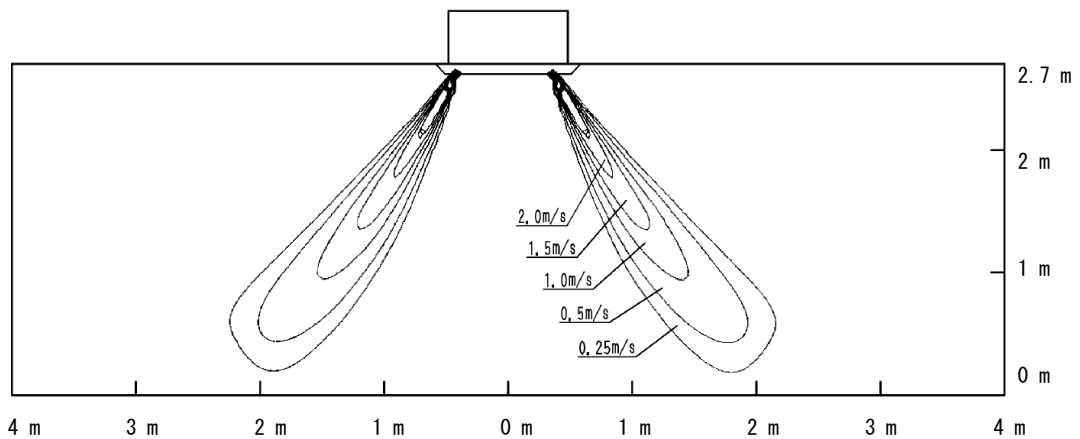

#### Air temperature distribution (heating)

Air flow direction: horizontal

Air discharge: all-round

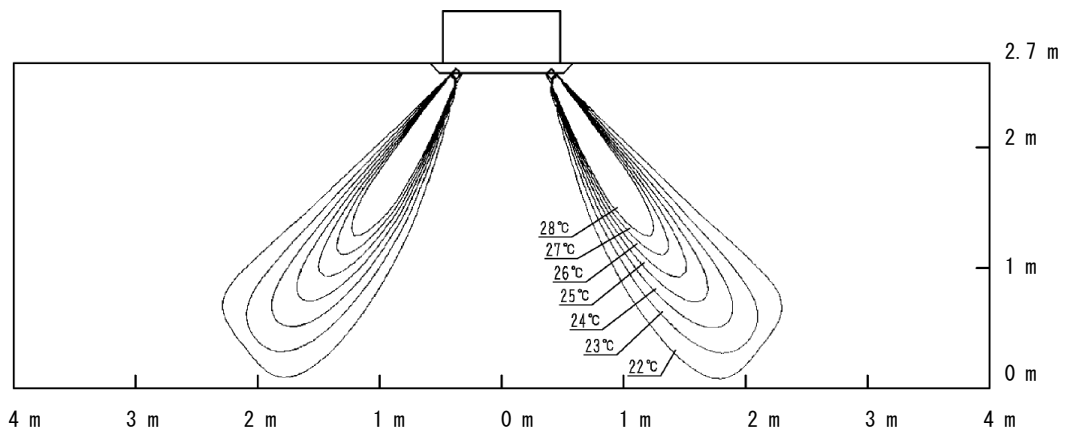

**4D106683**

# 9 Air flow patterns

## 9 - 2 Air Flow Pattern - Heating

### FCAG50A

#### Air velocity distribution (heating)

Air flow direction: horizontal

Air discharge: all-round

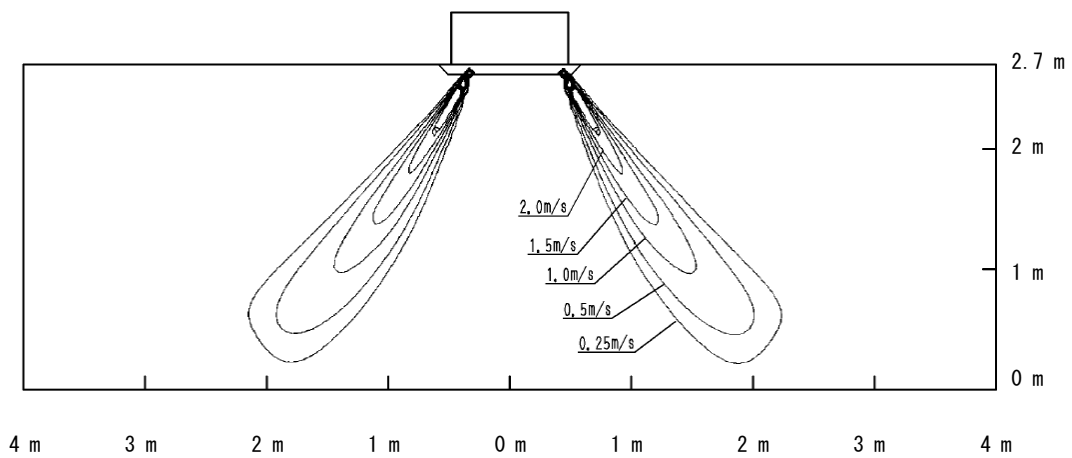

#### Air temperature distribution (heating)

Air flow direction: horizontal

Air discharge: all-round

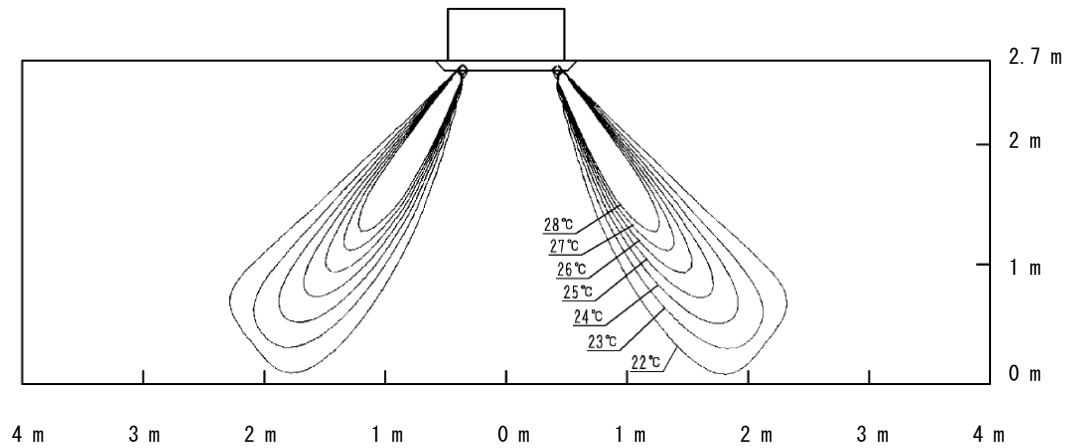

**4D106686**

# 9 Air flow patterns

## 9 - 2 Air Flow Pattern - Heating

9

### FCAG60A

#### Air velocity distribution (heating)

Air flow direction: horizontal

Air discharge: all-round

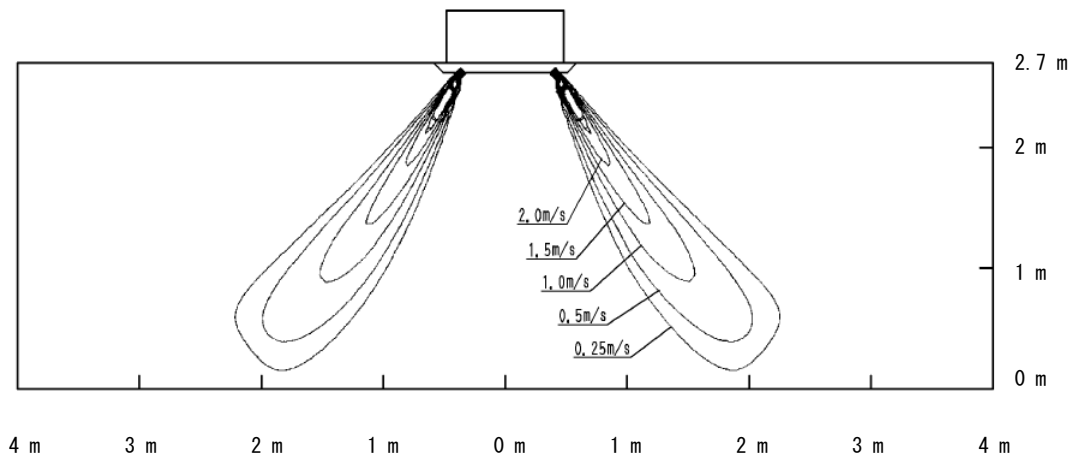

#### Air temperature distribution (heating)

Air flow direction: horizontal

Air discharge: all-round

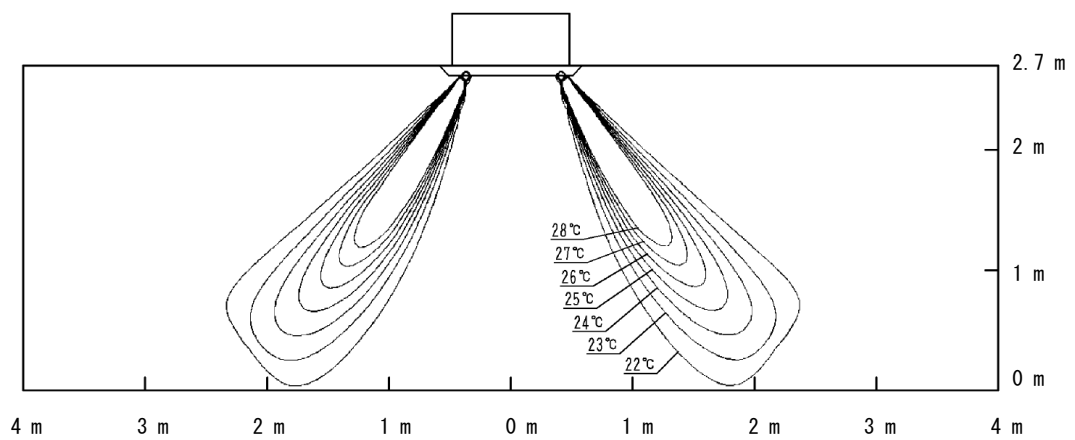

**4D106693**

# 9 Air flow patterns

## 9 - 2 Air Flow Pattern - Heating

### FCAG71A

#### Air velocity distribution (heating)

Air flow direction: horizontal

Air discharge: all-round

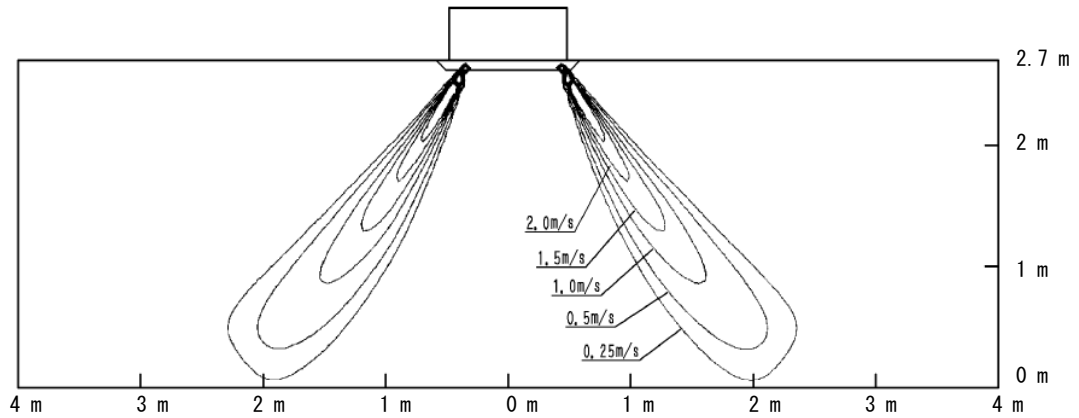

#### Air temperature distribution (heating)

Air flow direction: horizontal

Air discharge: all-round

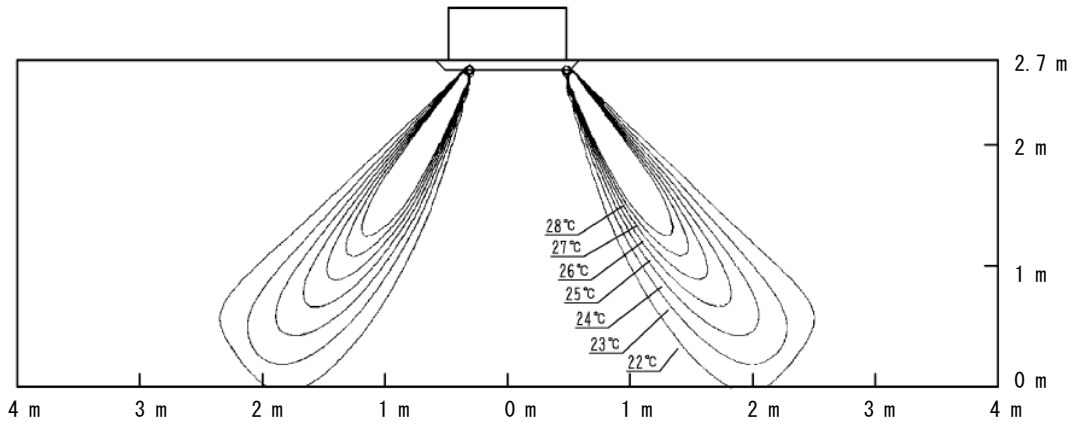

4D106171

# 9 Air flow patterns

## 9 - 2 Air Flow Pattern - Heating

9

### FCAG100A

#### Air velocity distribution (heating)

Air flow direction: horizontal

Air discharge: all-round

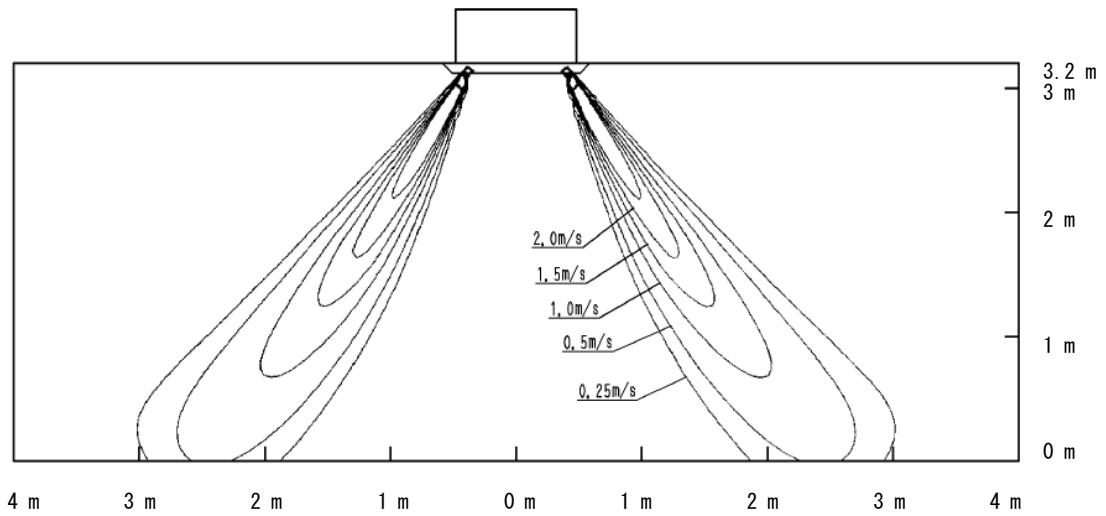

#### Air temperature distribution (heating)

Air flow direction: horizontal

Air discharge: all-round

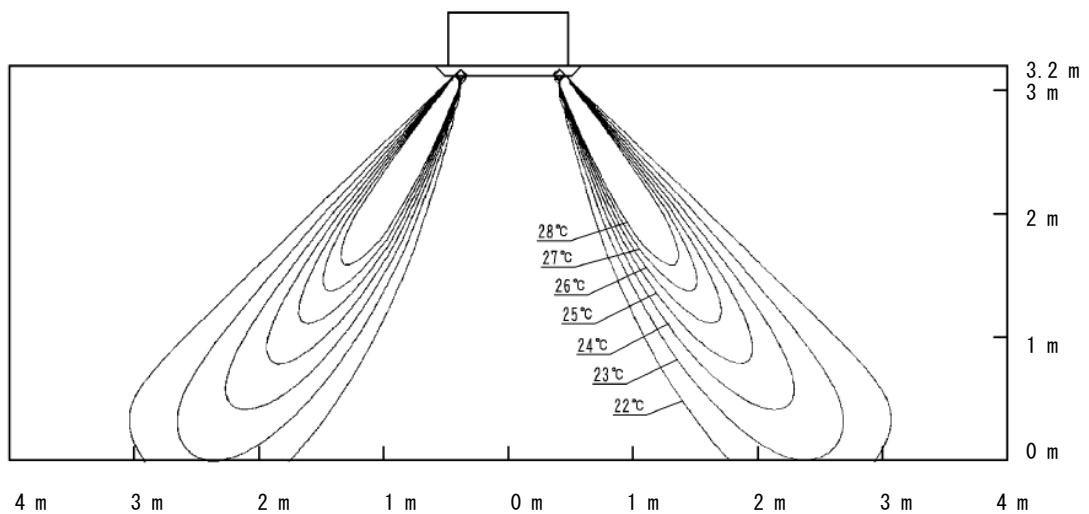

**4D106172**

## 9 Air flow patterns

### 9 - 2 Air Flow Pattern - Heating

# FCAG125A

#### Air velocity distribution (heating)

Air flow direction: horizontal

Air discharge: all-round

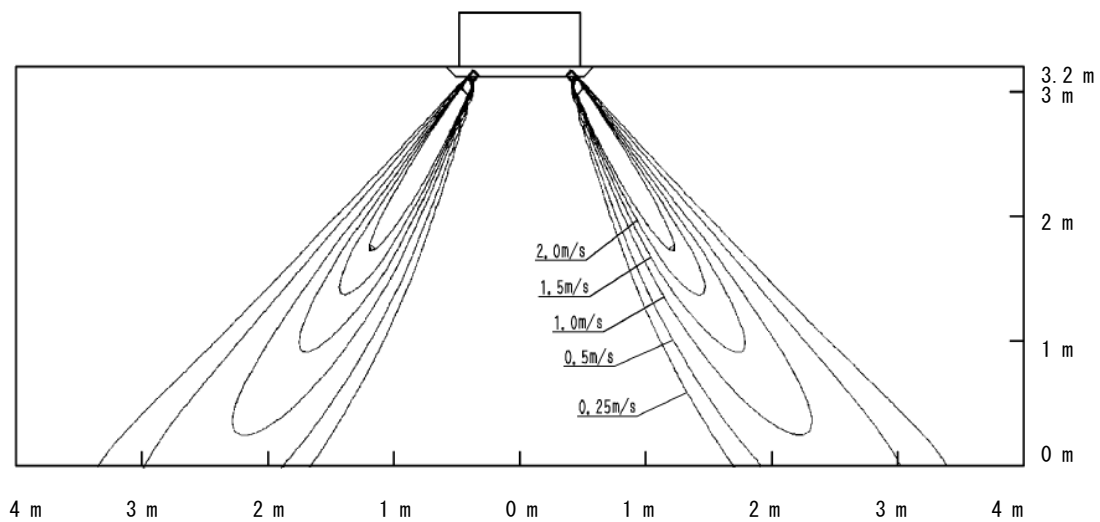

#### Air temperature distribution (heating)

Air flow direction: horizontal

Air discharge: all-round

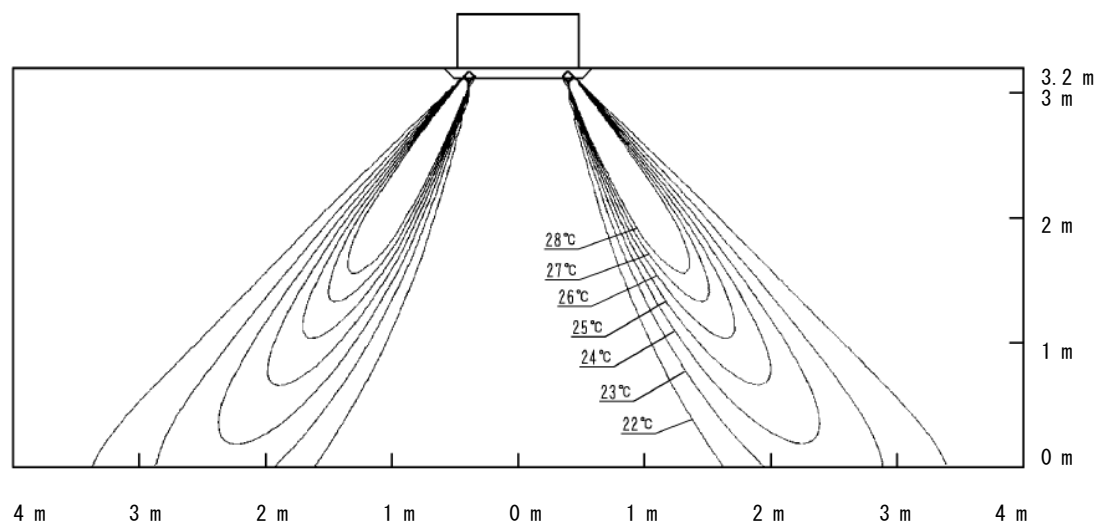

**4D106173**

# 9 Air flow patterns

## 9 - 2 Air Flow Pattern - Heating

9

### FCAG140A

#### Air velocity distribution (heating)

Air flow direction: horizontal

Air discharge: all-round

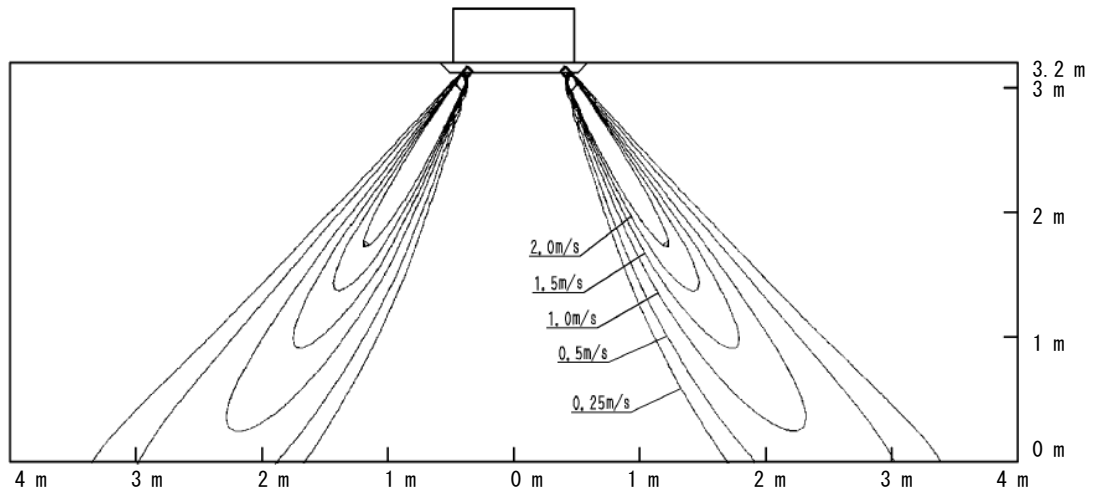

#### Air temperature distribution (heating)

Air flow direction: horizontal

Air discharge: all-round

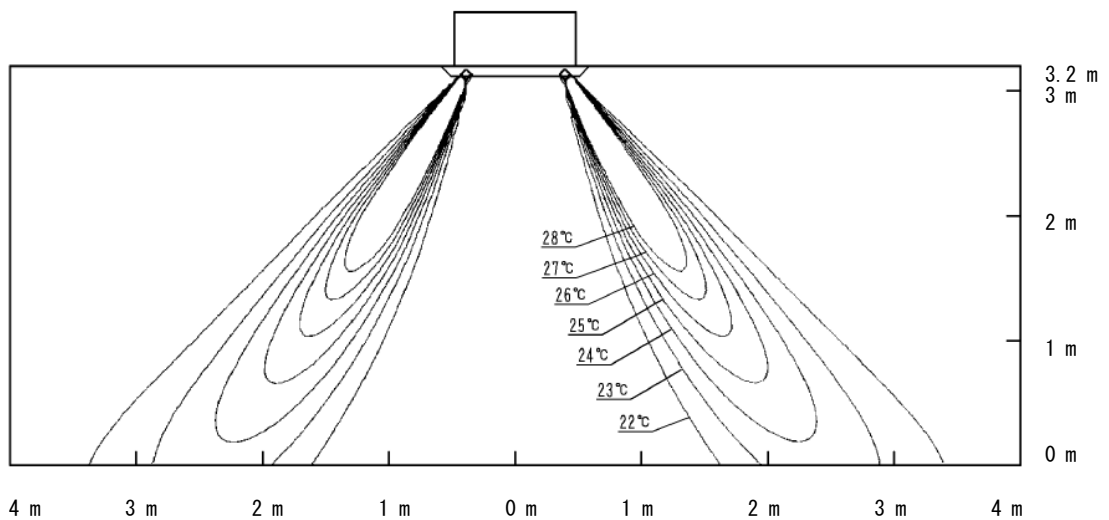

**4D106174**





Daikin Europe N.V. Naamloze Vennootschap - Zandvoordestraat 300, B-8400 Oostende - Belgium - [www.daikin.eu](http://www.daikin.eu) - BE 0412 120 336 - RPR Oostende

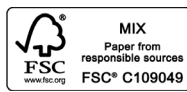
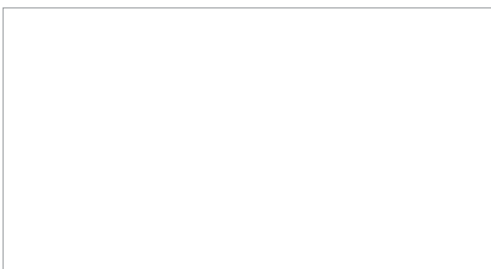

EEDEN17 07/17



Daikin Europe N.V. participates in the Eurovent Certified Performance programme for Liquid Chilling Packages and Hydronic Heat Pumps, Fan Coil Units and Variable Refrigerant Flow systems. Check ongoing validity of certificate: [www.eurovent-certification.com](http://www.eurovent-certification.com)



The present leaflet is drawn up by way of information only and does not constitute an offer binding upon Daikin Europe N.V.. Daikin Europe N.V. has compiled the content of this leaflet to the best of its knowledge. No express or implied warranty is given for the completeness, accuracy, reliability or fitness for particular purpose of its content and the products and services presented therein. Specifications are subject to change without prior notice. Daikin Europe N.V. explicitly rejects any liability for any direct or indirect damage, in the broadest sense, arising from or related to the use and/or interpretation of this leaflet. All content is copyrighted by Daikin Europe N.V.